



**DELLNER
BUBENZER**



MONITORING SYSTEM VSR-3 FOR SB BRAKES

BRAKING UNLIMITED

FEATURES

- Automatic power supply range switch 110-240 V AC
- One VSR-3 box can handle up to 2 brakes SB28 / SB23 / SB16
- Cable for sensors have a plug M12 on each end for easy troubleshooting
- Industrial display with 4 rows of 20 characters for indication of measurement data and error messages
- High ambient temperature range -20°C.....+70°C
- Protection class IP65
- Internal keypad for parameter change.
- Up to 20 m cable length from sensor to electronic box (Option).
- Brake operation cycle counter (up to 100 million Cycles)
- One common error relay contact

OPTIONS

- Stainless steel electronic box IP66
- sunshine protection cover for outdoor use

After many years of successful operation in the market, the brake condition monitoring systems VSR-2 have been improved.

The new system VSR-3 can handle double amount of sensors.



1. Parts of VSR-3 system for SB brakes

1.1 Pad wear sensors:

If the minimum brake pad thickness is reached, the sensors (A) send a signal to the VSR-3.

1.2 Temperature sensors:

A pair of Pt100 sensors (B) measures the temperature of the each brake pad. If the temperature is too high or if the temperature is unequal from left to right side the unit generates a signal that is displayed in the panel.

1.3 Stroke sensor:

The analogue sensor measures the position of the thruster piston rod. The reserve stroke is measured and checked that it is at the perfect position of 10 mm when the brake is correctly closed. The maximum measurement range is 100 mm.

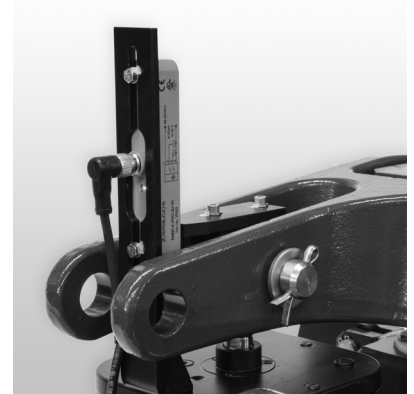

Stroke sensor

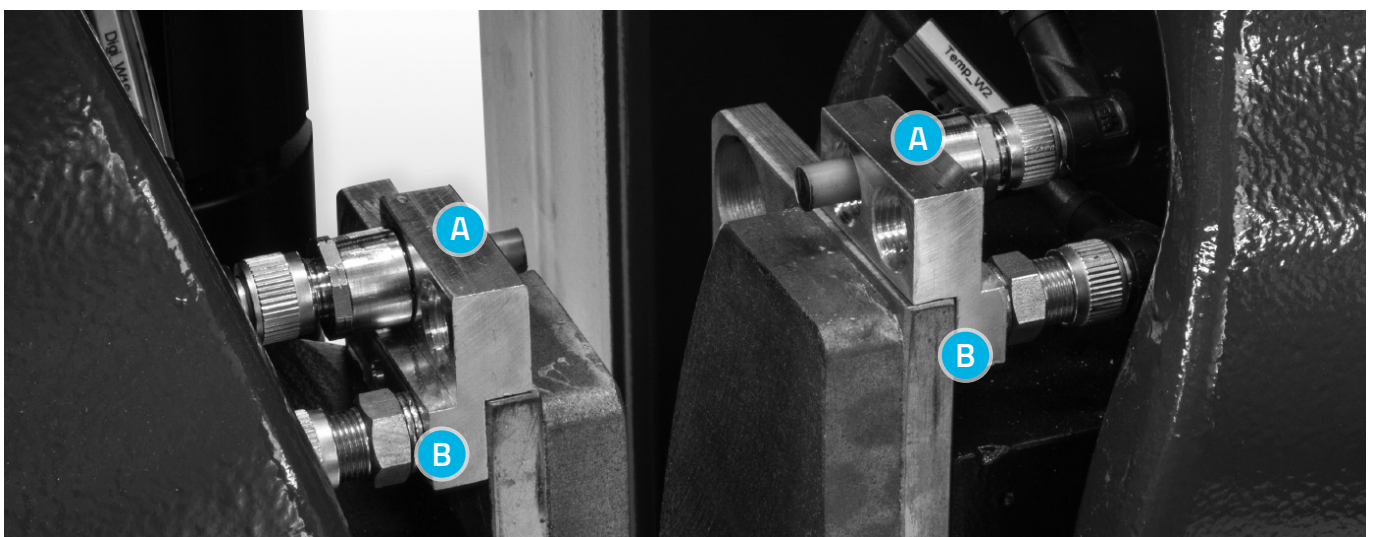

Pad wear and temperature sensors

Brake type SB28.3 with BUEL thruster and VSR-3 monitoring system.

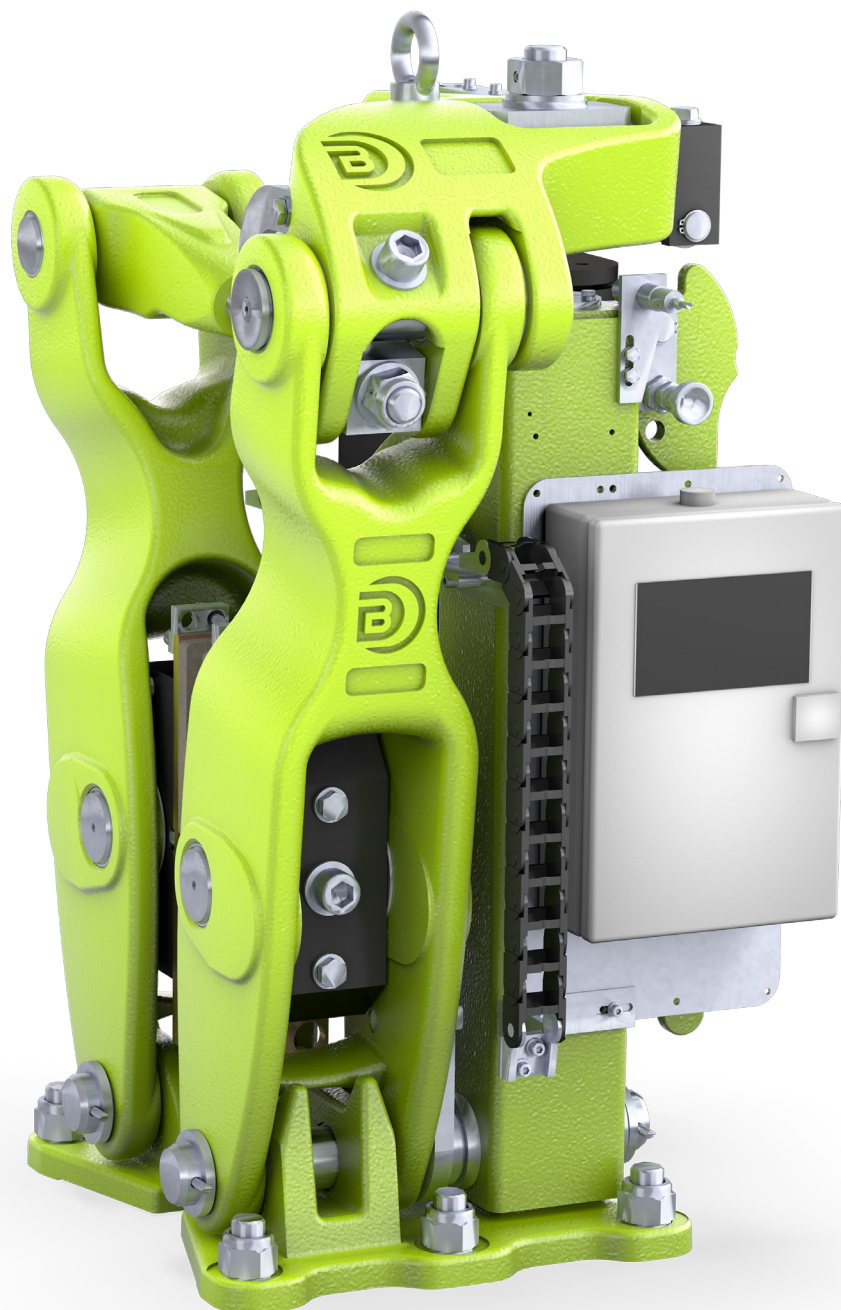

Typical position of the VSR-3 unit.
(Other options available)

1.4 Electrical diagram VSR-3 for SB brakes

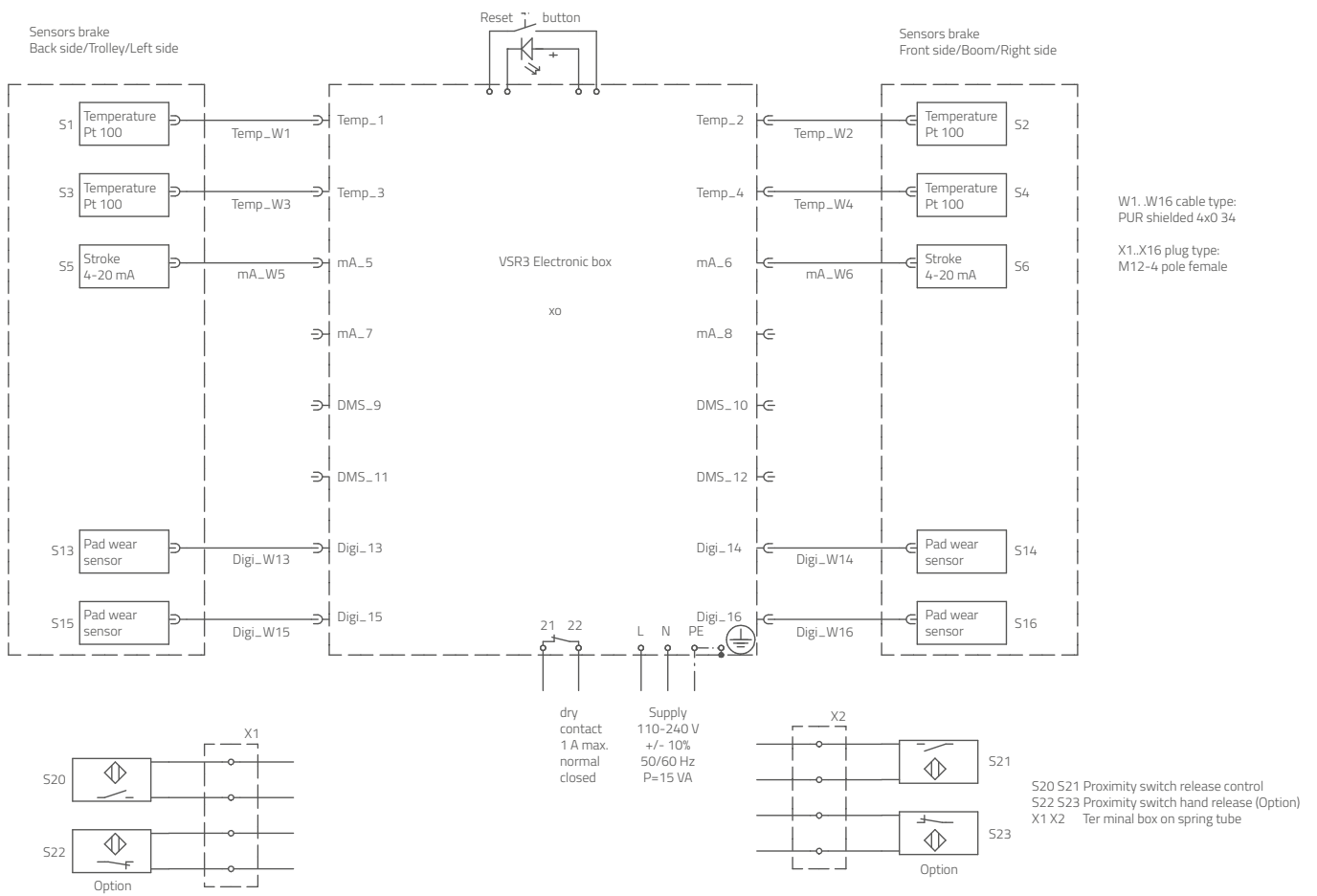

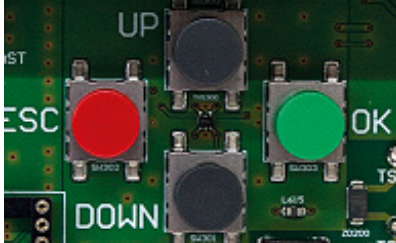

Keypad

2. Control elements

2.1 Display:

All measured analogue signals, digital signals and error messages are shown on the display in English language. The display is readable under direct sunshine and has a LED backlight for use in a dark environment, such as steel mills.

2.2 Keypad:

With the internal keypad, the user can adjust parameters such as changing the temperature display from Celsius (°C) to Fahrenheit (°F).

2.3 Reset button:

The LED pushbutton on top of the electronic box indicates a wrong brake adjustment by a flashing red light. After the problem on the brake is solved, the status of the VSR-3 can be reset to normal operation by pushing the button.

Internal circuit board



Dimensions VSR-3

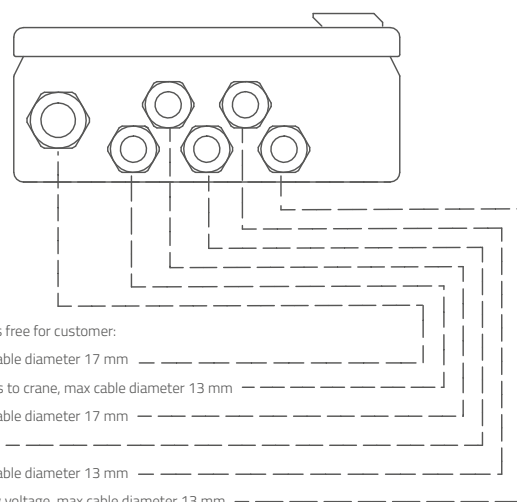
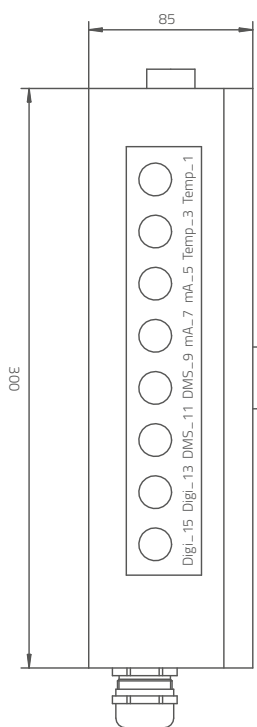
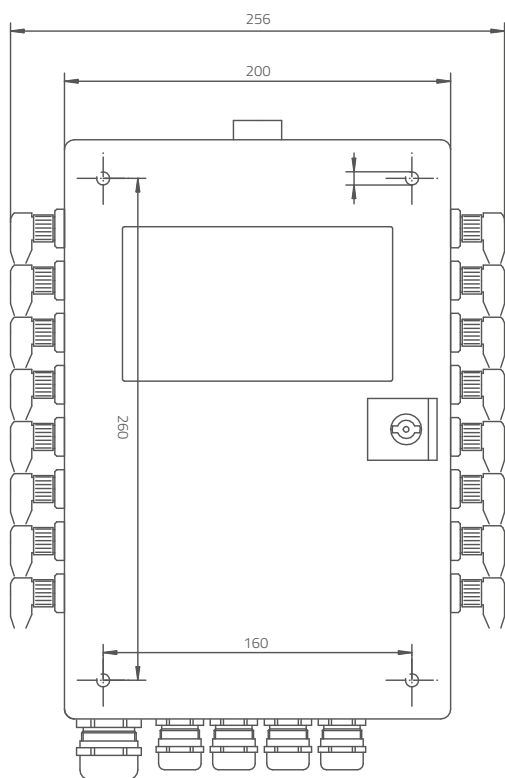

Cable glands free for customer:

M25: Max cable diameter 17 mm

M20: Signals to crane, max cable diameter 13 mm

M20: Max cable diameter 17 mm

M20: spare

M20: Max cable diameter 13 mm

M20: Supply voltage, max cable diameter 13 mm



DELLNER BUBENZER



DELLNER BUBENZER

Germany GmbH

Friedrichshuettenstr. 1

57548 Kirchen-Wehbach

Germany

+49 2741 9488 0

info.de@dellnerbubenzer.com

www.dellnerbubenzer.com